

DDC Controls Package Manual

VHC-36, -42 and -50

Operation Instructions Manual

Model: VHC-36, VHC-42, VHC-50



Table of Contents

Overview.....	3
Features and Benefits	3
Terminal Strip.....	3
Control Details.....	4
Stand Alone Operation.....	4
Network Operation.....	4
Ventilation Control Scheduling Modes.....	4
Temperature Control Configuration.....	5
Setpoint Adjustment.....	6
VHC Sequence of Operation.....	7
DDC Interface	11
Appendix A: Control Wiring Connections Example	13
Appendix B: DDC Points Reference Guide.....	16
Appendix C: Standard Network Practice	19
Appendix D: DDC Troubleshooting Guide.....	21



©Venmar CES Inc. 2012. All rights reserved throughout the world.

Illustrations cover the general appearance of Venmar CES products at the time of publication and Venmar CES reserves the right to make changes in design and construction at any time without notice.

™® The following are trademarks or registered trademarks of their respective companies: Variable Refrigerant Control from Venmar CES.

CES Group, LLC d/b/a Venmar CES furnishes equipment pursuant to its then-current Terms and Conditions of Sale and Limited Warranty, copies of which can be found under the Terms & Conditions of Sale and Warranty link at www.ces-group.com. Extended warranties, if any, shall be as offered and acknowledged in writing by Venmar CES.

Manufacturer reserves the right to discontinue or change specifications or designs without notice or obligation.

Overview

The DDC control package is programmed for a range of temperature control and scheduling modes which are field selectable. The control package enables the VHC to control discharge air temperature, room/return air temperature or discharge in conjunction with room air temperature based on sensor readings. It can also be used to control the amount of air being recirculated back into the building.

This manual provides instructions and information on configuring and adjusting the control for a specific stand alone or networking application.

Features and Benefits

- No extra controls needed to accommodate discharge air temperature control.
- A room thermostat may be used to control room heating and cooling.
- A room humidistat may be used to control room humidity.
- Native BACnet firmware with MS/TP RS485 protocol.
- Can be optionally interfaced with many different protocols with the use of a terminal server, like Lonworks, Modbus, Metasys, etc.

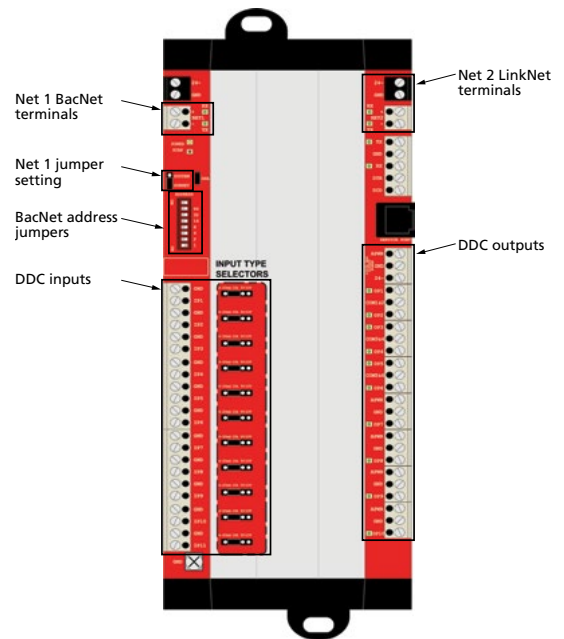

Figure 1: DDC layout

Terminal Strip

A low voltage Field Wiring (FW) interface terminal strip is provided for shipped loose or field supplied controls, sensor or interlock connections to fully integrate the unit. Interconnections to a BMS are minimal. Refer to Appendix

G and H in the VHC-36, 42 and 50 Installation, Operation and Maintenance Instructions Manual, for example of start-up connections, plus input and output connections available.

Control Details

Stand Alone Operation

The DDC control package includes a four-button user interface called the BacStat II. This device can be mounted anywhere and when room air tempering is needed, can be configured as a room thermostat. A wide range of configuration options are included and can be accessed through the BacStat (see Figure 2).

For stand alone operation an external dry contact (ex: remote time clock, CO₂ sensor or manual selector switch, etc.) for scheduling mode must be provided by others or is available as an accessory item. This is the only connection required to start single-speed units.



Figure 2: BacStat II

Network Operation

The Delta DDC is a native BACnet device that can communicate over an RS-485 network running between 9,600 and 76,800 baud. Delta products are tested for interoperability between multiple vendors at the BACnet Testing Laboratory (BTL). The use of a BTL listed front end will greatly simplify network installation and allow problemfree communication.

When connected to the network, all scheduling can be taken over by the front end control system (provided by others). Additional access is provided to dozens of control variables which give the Building Management System as much control as needed (with the exception of critical functions, such as the defrost strategy and other fail safes).

Ventilation Control Scheduling Modes

Occupied Ventilation (Ov)

Jumper across FW 304–305. This is the main mode that will enable the unit to run in 100% fresh air mode. Free cooling and defrost will initiate based on the setpoint.

Unoccupied (Un)

No jumpers on any of the terminals 304, 305, 306, 307 or 308. The unit will turn off.

Unoccupied Recirculation (Ur) (Optional)

Jumper across FW 305–306. The unit will turn off unless there is a call for heating/cooling or dehumidification across the heating/cooling or dehumidification contacts. This call must come from an optional thermostat or humidistat. The unit will run in recirc mode upon a call.

Occupied Recirculation (Or) (Optional)

Jumper across FW 306–307. The unit will run and recirc a percentage of air. The outside and exhaust air dampers may be adjusted to open a certain percentage, thus reducing the amount of fresh air and increasing the amount or recirc air.

Adjust the following parameters:

#143 – Outside Air Damper Minimum Setpoint

- Limits: 0–100%
- Factory set: 100%
- BACnet variable: AV150
- Function: The outside air damper minimum setpoint is set in conjunction with the exhaust air damper minimum setpoint to allow for the required recirculation air.

#144 – Exhaust Air Damper Minimum Setpoint

- Limits: 0–100%
- Factory set: 100%
- BACnet variable: AV151
- Function: The exhaust air damper minimum setpoint is set in conjunction with the outside air damper minimum setpoint to allow for the required recirculation air.

Building Management System Scheduling

Alternatively the software point MV12 can be used to schedule the unit as described above. If this method is

being used then you must not provide any jumpers to terminals 304, 305, 306, 307 or 308.

The remote unit control multi-state variable is used to enable the unit through a Bacnet interface. Set MV12 to:

- 2 for unoccupied mode.
- 4 for occupied recirculation mode (optional).
- 6 for unoccupied recirculation mode (optional).
- 10 for ventilation mode.

Temperature Control Configuration

The VHC unit can be configured to control building temperature a variety of ways. Adjust #153 – Zone Configuration to change temperature control to discharge air, room air or return air control. Default settings from factory allow the unit to be controlled by discharge air temperature.

Adjust the following setpoint:

#153 – Zone Configuration

- Limits: NO, RM, RET
- Factory set: NO
- BACnet variable: MV11 function – Zone configuration allows the unit to be used for zone heating and cooling.
 - NO: No zone control (discharge only)
 - RM: Room air zone control (BacStat II)
 - RET: Return air zone control (RA temp sensor)

Discharge Air Temperature Control (MV11 = NO)

This type of control is used when the VHC is required to maintain a discharge temperature only. The BacStat will not provide room control in this mode. An optional thermostat may be used to provide additional heating or cooling when connected to the heating override or cooling override terminals on the FW terminal strip (see [Override Contact Control \(Optional\)](#)).

Adjust the following setpoints:

#107 – Cooling Setpoint

- Limits: 50–80°F [10–27°C]
- Factory set: 60°F
- BACnet variable: AV10 function – The cooling setpoint is the temperature that the reheat will heat the supply air up to (summer mode only).

#115 – Coil Leaving Setpoint

- Limits: 40–65°F [4–18°C]
- Factory set: 55°F
- BACnet variable: AV143 function – The coil leaving setpoint is the temperature that the cooling coil will cool the coil leaving air temperature down to during discharge air temperature control (summer mode only).

#111 – Heating Setpoint

- Limits: 50–105°F [10–40°C]

- Factory set: 80°F
- BACnet variable: AV20
- Function: The heating setpoint is the temperature that the post heat will heat the supply air up to during discharge air temperature control (winter mode only).

Room Air Temperature Control (MV11 = RM)

The BacStat must be mounted in the room for this type of control.

This type of control is used when you want to maintain a room temperature. The VHC will heat/cool based on the BacStat temperature. An optional thermostat can be used to provide additional heating or cooling when connected to the heating override or cooling override terminals on the FW terminal strip (see [Override Contact Control \(Optional\)](#)).

Adjust the following setpoints:

#147 – Summer Zone Setpoint

- Limits: 60–80°F [15–25°C]
- Factory set: 70°F
- BACnet variable: AV84 function – The summer zone setpoint is the room or return air setpoint for summer mode.

#150 – Winter Zone Setpoint

- Limits: 60–80°F [15–25°C]
- Factory set: 70°F
- BACnet variable: AV87
- Function: The winter zone setpoint is the room or return air setpoint for winter mode.

Return Air Temperature Control (MV11 = RET)

This type of control is used when you want to maintain a return temperature. This application is typical for VHC units providing air to several rooms. The VHC will heat/cool based on the return air temperature. An optional thermostat can be used to provide additional heating or cooling when connected to the heating override or cooling override terminals on the FW terminal strip (see [Override Contact Control \(Optional\)](#)).

Adjust the following setpoints:

#147 – Summer Zone Setpoint

- Limits: 60–80°F [15–25°C]
- Factory set: 70°F
- BACnet variable: AV84
- Function: The summer zone setpoint is the room or return air setpoint for summer mode.

#150 – Winter Zone Setpoint

- Limits: 60–80°F [15–25°C]
- Factory set: 70°F
- BACnet variable: AV87
- Function: The winter zone setpoint is the room or return air setpoint for winter mode.

Override Contact Control (Optional)

Alternatively the unit may be controlled by its heating, cooling, dehumidification contacts. The heating contact is only provided on units with heating options and the cooling/dehumidification contact is only provided on units with cooling options. An optional room thermostat (or contact closure) may be used to provide a dry contact closure across terminals FW 314–315 for cooling, or FW 318–319 for heating.

These override contacts can be used in any of the three temperature control modes listed above. When the unit

is running normally, it will run based on its corresponding setpoints. When an override contact is made, the unit will change its setpoints as follows:

#118 – Coil Override Leaving Setpoint

- Limits: 40–65°F [4–18°C]
- Factory set: 50°F
- BACnet variable: AV146
- Function: The coil override leaving setpoint is the temperature that the cooling coil will cool the coil leaving air temperature down to during room air temperature/humidity control (summer mode only).

#121 – Heating Override Setpoint

- Limits: 50–105°F [10–40°C]
- Factory set: 90°F
- BACnet variable: AV140
- Function: The heating override setpoint is the temperature that the post heat will heat the supply air up to during room air temperature control (winter mode only).

An optional humidistat may be used to provide a dry contact closure across terminals FW 316–317 for dehumidification.

Setpoint Adjustment

In order to give more flexibility to the user, the setpoints are fully adjustable from the BacStat interface. For a full modulating system (ex. SCR electric heat) you only need to adjust the setpoint value. When using a binary switch (ex. summer/winter changeover) or when staging a device (ex. compressors), a span or differential is needed to separate the 'On' and 'Off' point to eliminate the fast cycling. In this case, Venmar CES uses the Setpoint-Span-Reset adjustment method.

- The Setpoint is the value to reach.
- The Span is the band width between the 'On' and 'Off' point.
- The Reset is the percentage of the span value under the setpoint (refer to Figure 3).

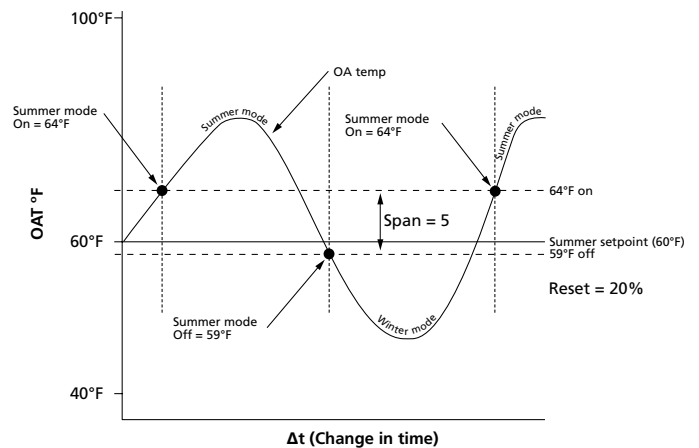

For this example:
 Sum_Stp = 60°F Sum_Span = 5 Sum_Reset = 20
 To calculate:
 Summer switch On = Sum_Stp + (Sum_Span * ((100 - Sum_Rst) / 100))
 Summer switch Off = Sum_Stp - (Sum_Span * (Sum_Rst / 100))

Figure 3: Setpoint adjustment example

VHC Sequence of Operation

Ventilation

IMPORTANT

The following conditions may not occur in the exact order as listed.

On a call for occupied ventilation (occupancy contact closed):

- Wheel starts (not in free cooling).
- Recirculation damper closes (if equipped).
- Exhaust air damper opens.
- Outside air damper opens.
- After exhaust air damper opens; exhaust blower starts.
- After outside air damper opens; supply blower starts.

Occupied Recirculation

On a call for occupied recirculation (if equipped) (occupied recirculation contacts closed):

- Wheel starts (not in free cooling).
- Recirculation damper closes.
- After exhaust air damper opens; exhaust blower starts.
- After supply air damper opens; supply blower starts.
- Return air damper opens.
- Outside and exhaust air dampers modulate to the damper minimum setpoints.

Unoccupied Recirculation

On a call for unoccupied recirculation (if equipped) (unoccupied recirculation contacts closed and a call for cooling or heating):

- Wheel stops.
- Recirculation damper opens.
- Exhaust air damper closes.
- Outside air damper closes.
- Supply blower starts.

Summer/Winter Changeover

The summer setpoint, parameter #104, is the temperature setpoint that the outdoor air temperature sensor must reach in order to change from heating to cooling or visa versa. When the outdoor air temperature is above this setpoint, you will be in summer mode and your heating components will be disabled. When the outdoor air temperature is below this setpoint, you will be in winter mode and your cooling components will be disabled.

Adjust the following setpoints:

#104 – Summer Setpoint

- Limits: 5–80°F [–15–27°C]
- Factory set: 60°F
- BACnet variable: AV5
- Function: The summer setpoint is the temperature for the unit to changeover between summer and winter modes of operation.

#105 – Summer Span

- Limits: 1–8°F [0.5–5°C]
- Factory set: 4°F
- BACnet variable: AV6
- Function: The summer span is the differential above and below the summer setpoint.

#106 – Summer Reset

- Limits: 0–100%
- Factory set: 50%
- BACnet variable: AV7
- Function: The summer reset is the shift in the span below the summer setpoint by X%.

Cooling

Free cooling

Free cooling can be disabled by adjusting parameter #130.

Adjust the following setpoint:

#130 – Free Cooling Select

- Limits: On/off
- Factory set: On
- BACnet variable: BV61
- Function: This variable enables or disables free cooling.

Dry Bulb Setpoint (On/Off)

If the outside air temperature is above the summer setpoint (selectable) and if the outside air temperature is less than the return air temperature and less than the free cooling temperature setpoint range, the wheel stops.

Adjust the following setpoints:

#127 – Dry Bulb Free Cooling Setpoint

- Limits: 40–80°F [5–27°C]
- Factory set: 65°F
- BACnet variable: AV60
- Function: The dry bulb free cooling setpoint is the temperature that the unit will go into free cooling.

#128 – Dry Bulb Free Cooling Span

- Limits: 4–20°F [2–12°C]
- Factory set: 4°F
- BACnet variable: AV61
- Function: The dry bulb free cooling span is the differential above and below the free cooling setpoint.

#129 – Dry Bulb Free Cooling Reset

- Limits: 0–100%
- Factory set: 50%
- BACnet variable: AV62
- Function: The enthalpy free cooling reset is the percentage of the span value under the setpoint.

Setpoint Enthalpy (On/Off)

If the outside air temperature is above the summer setpoint (selectable) and if the outside air enthalpy is in the enthalpy free cooling setpoint range, the wheel stops.

Adjust the following setpoints:

#124 – Enthalpy Free Cooling Setpoint

- Limits: 10–70 Btu/lbs [23–163 Joules/Gram]
- Factory set: 20 Btu/lbs
- BACnet variable: AV45
- Function: The enthalpy free cooling setpoint is the measured enthalpy that the unit will go into free cooling.

#125 – Enthalpy Free Cooling Span

- Limits: 5–20 Btu/lbs [11–46 Joules/Gram]
- Factory set: 5 Btu/lbs
- BACnet variable: AV46
- Function: The enthalpy free cooling span is the differential above and below the free cooling setpoint.

#126 – Enthalpy Free Cooling Reset

- Limits: 0–100%
- Factory set: 50%
- BACnet variable: AV47
- Function: The enthalpy free cooling reset is the percentage of the span value under the setpoint.

Differential Enthalpy (On/Off)

If the outside air temperature is above the summer setpoint (selectable) and if the outside air enthalpy is less than return air enthalpy and in the enthalpy free cooling setpoint range, the wheel stops.

Adjust the following setpoints:

#124 – Enthalpy Free Cooling Setpoint

- Limits: 10–70 Btu/lbs [23–163 Joules/Gram]
- Factory set: 20 Btu/lbs
- BACnet variable: AV45
- Function: The enthalpy free cooling setpoint is the measured enthalpy that the unit will go into free cooling.

#125 – Enthalpy Free Cooling Span

- Limits: 5–20 Btu/lbs [11–46 Joules/Gram]
- Factory set: 5 Btu/lbs
- BACnet variable: AV46
- Function: The enthalpy free cooling span is the differential above and below the free cooling setpoint.

#126 – Enthalpy Free Cooling Reset

- Limits: 0–100%
- Factory set: 50%
- BACnet variable: AV47
- Function: The enthalpy free cooling reset is the percentage of the span value under the setpoint.

Variable Free Cooling (Dry Bulb Setpoint Wheel VFD Modulation)

If the outside air temperature is above the summer setpoint (selectable) and if the outside air temperature is less than the return air temperature and less than the supply

air temperature setpoint, the wheel modulates to the wheel leaving temperature setpoint.

Dx Cooling, WSHP Cooling, One Compressor, Optional VRC® (Discharge Air Temperature Control)

If the outside air temperature is above the summer setpoint (selectable) and if the coil leaving air temperature rises above the coil leaving air temperature setpoint (selectable), the first compressor starts. Modulate compressor to coil leaving air temperature setpoint. Reheat heats up the supply air to the cooling setpoint (if equipped).

Dx Cooling, WSHP Cooling, Two Compressors, Single Compressor, Two-stage (Discharge Air Temperature Control)

If the outside air temperature is above the summer setpoint (selectable) and if the coil leaving air temperature rises above the coil leaving air setpoint (selectable), the first compressor starts. If more cooling is needed based on the coil leaving air temperature setpoint, after staging delay, the second compressor starts. Reheat heats up the supply air to the cooling setpoint (if equipped).

Dx Cooling, WSHP Cooling, Two Compressors, First Compressor VRC (Discharge Air Temperature Control)

If outside air temperature is above summer setpoint (selectable), and if coil leaving air temperature rises above coil leaving air setpoint (selectable), first compressor starts and modulates to maintain setpoint. If more cooling is needed based on coil leaving air temperature setpoint, after staging delay, second compressor starts. The first compressor will continue to modulate to maintain coil leaving air temperature. Reheat heats up supply air to cooling setpoint (if equipped)

Dx Cooling, WSHP Cooling, One Compressor, Optional VRC (Room Air Temperature Control)

If the outside air temperature is above the summer setpoint (adjustable) and if the (return) room air temperature rises above the summer zone setpoint and the coil leaving air temperature is above the coil leaving setpoint, the first compressor starts. Compressor modulates to coil leaving air temperature setpoint (adjustable). This continues until (return) room air temperature is satisfied.

Dx Cooling, WSHP Cooling, Two Compressors or Two-stage Single Compressor (Room Air Temperature Control)

If the outside air temperature is above the summer setpoint (selectable) and if the (return) room air temperature rises above the summer zone setpoint and the coil leaving air is above the coil leaving setpoint, the first compressor starts. If more cooling is needed, based on the coil leav-

ing air temperature setpoint, after staging delay, second compressor starts. This process continues until the (return) room air temperature is satisfied.

Dx Cooling, WSHP Cooling, Two Compressors, First Compressor VRC® (Room Air Temperature Control)

If outside air temperature is above summer setpoint (selectable), and if (return) room air temperature rises above summer zone setpoint and coil leaving air is above coil leaving setpoint, first compressor starts and modulates to maintain setpoint. If more cooling is needed based on coil leaving air temperature setpoint, after staging delay, second compressor starts. The first compressor will continue to modulate to maintain coil leaving air temperature. Re-heat heats up supply air to cooling setpoint (if equipped).

IMPORTANT – COMPRESSOR SAFETY

If either non-freeze switch is made for over two minutes, the last on compressor shuts down for lockout time (selectable, minimum of five minutes). If the non-freeze switch is on for another two minutes, then the first on compressor shuts down for lockout time. If the low pressure switch has tripped three times, the compressor will lock off until power is removed from the unit. If on either circuit, the high pressure switch is made, their respective compressor shuts down (manual reset required). There is a minimum of a five minute anti-cycling time before compressors will stage.

Dehumidification (Room Air Temperature Control)

If the outside air temperature is above the summer setpoint (selectable) and if the return (room) air humidity rises above the return (room) air humidity setpoint, based on optional room humidistat, the first compressor starts. Re-heat heats up the supply air to the cooling setpoint (selectable). If more cooling is needed, based on the coil override leaving air temperature setpoint, after the staging delay, the second compressor starts (if equipped).

This process continues until the return (room) air humidity is satisfied.

Chilled Water (Discharge Air Temperature Control)

If the outside air temperature is above the summer setpoint (selectable), the chilled water valve modulates to maintain the coil leaving air temperature strategy to maintain the coil leaving air temperature setpoint (selectable). Reheat heats up air to the cooling setpoint (if equipped).

Chilled Water (Room Air Temperature Control)

If the outside air temperature is above the summer setpoint (selectable) and if the room air temperature rises above the room air setpoint, the chilled water valve modulates based on a sliding supply air temperature strategy

to maintain the supply air between the summer zone setpoint and the minimum supply temperature setpoint.

Heating

Gas or Electric SCR (Discharge Air Temperature Control)

If the outside air temperature is below the summer setpoint (selectable), the gas module is enabled. Gas burners modulate to maintain the heating setpoint (selectable).

Gas or Electric SCR (Room Air Temperature Control)

If the outside air temperature is below the summer setpoint (selectable), the gas module is enabled. If the (return) room air temperature drops below the winter zone setpoint, the gas burners (or electric elements) modulate based on a sliding supply air strategy to maintain the supply air between the winter zone setpoint and the maximum supply air temperature setpoint, until the room air temperature is satisfied.

Gas or Electric Stage (Discharge Air Temperature Control)

If the outside air temperature is below the summer setpoint (selectable), the electric post heater is enabled. The heating elements stage to maintain the heating setpoint.

Gas or Electric Stage (Room Air Temperature Control)

If the outside air temperature is below the summer setpoint (selectable), the electric post heater is enabled. If the (return) room air temperature drops below the winter zone setpoint, the heating elements modulate based on a sliding supply air strategy to maintain the supply air between the winter zone setpoint and the maximum supply air temperature setpoint, until the room air temperature is satisfied.

Hot Water (Discharge Air Temperature Control)

If the outside air temperature is below the summer setpoint (selectable), the hot water valve modulates to maintain the heating setpoint (selectable).

Hot Water (Room Air Temperature Control)

If the outside air temperature is below the summer setpoint (selectable), and if the (return) room air temperature drops below the winter zone setpoint, the hot water valve modulates based on a sliding supply air strategy to maintain the supply air between the winter zone setpoint and the maximum supply temperature setpoint, until the room air temperature is satisfied.

WSHP Heating, One Compressor, Optional VRC® (Discharge Air Temperature Control)

If outside air temperature is below summer setpoint (selectable), and if coil leaving air temperature rises above heating setpoint (selectable), first compressor starts. Modulate compressor to heating setpoint. Additional postheat will heat up supply air if heating setpoint cannot be maintained (if equipped).

WSHP Heating, Two Compressors, or Two-stage Single Compressor (Discharge Air Temperature Control)

If outside air temperature is below summer setpoint (selectable), and if supply air temperature rises above heating setpoint (selectable), first compressor starts. If more heating is needed based on heating setpoint, after staging delay, second compressor starts. Additional postheat will heat up supply air if heating setpoint cannot be maintained (if equipped).

WSHP Heating, Two Compressors, First Compressor VRC (Discharge Air Temperature Control)

If outside air temperature is below summer setpoint (selectable), and if coil leaving air temperature rises above heating setpoint (selectable), first compressor starts and modulates to maintain setpoint. If more cooling is needed based on heating setpoint, after staging delay, second compressor starts. The first compressor will continue to modulate to maintain coil leaving air temperature. Additional postheat will heat up supply air if heating setpoint cannot be maintained (if equipped).

WSHP Heating, One Compressor, Optional VRC (Room Air Temperature Control)

If outside air temperature is below summer setpoint (adjustable), and if (return) room air temperature drops below winter zone setpoint and coil leaving air temperature is below heating setpoint, first compressor starts. Compressor modulates to coil leaving air setpoint (adjustable). This continues until (return) room air temperature is satisfied. Additional post heat will heat up supply air if heating setpoint cannot be maintained (if equipped).

WSHP Heating, Two Compressors, or Two-stage Single Compressor (Room Air Temperature Control)

If outside air temperature is below summer setpoint (selectable), and if (return) room air temperature rises above winter zone setpoint and coil leaving air is above heating setpoint, first compressor starts. If more cooling needed based on heating setpoint, after staging delay second compressor starts. This continues until (return) room air temperature is satisfied. Additional post heat will heat up supply air if heating setpoint cannot be maintained (if equipped).

WSHP Heating, Two Compressors, First Compressor VRC (Room Air Temperature Control)

If outside air temperature is below summer setpoint (selectable), and if (return) room air temperature rises above winter zone setpoint and coil leaving air is above heating setpoint, first compressor starts and modulates to maintain setpoint. If more cooling is needed based on heating setpoint, after staging delay, second compressor starts. The first compressor will continue to modulate to maintain coil leaving air temperature. Additional post heat will heat up supply air if heating setpoint cannot be maintained (if equipped).

WSHP Economizer Coil

If the outside air temperature is above summer setpoint (adjustable) and if the water entering temperature is below the economizer coil setpoint (adjustable) the economizer coil valve will modulate to maintain the coil leaving air temperature. If the economizer coil valve is open 100% for more than two minutes, then the mechanical cooling will be allowed to stage on. The economizer coil valve will remain open while in mechanical cooling until the water entering temperature is above the economizer coil setpoint (adjustable).

With both the economizer coil and free cooling options, if the outside air temperature is above summer setpoint and is in the free cooling range, then the economizer coil valve will close and temperature control will follow free cooling. If the outside air temperature rises above the free cooling range and the water entering temperature is below the economizer setpoint (adjustable) then the economizer coil valve will modulate and mechanical cooling will stage on to maintain the coil leaving air temperature as above.

WSHP Freeze Protection

If the unit has a water leaving temperature sensor and this temperature goes below the water leaving temperature setpoint (adjustable) then the compressor is locked off and the WSHP valve is opened.

WSHP Head Pressure Control

If the outside air temperature is above the summer setpoint (adjustable) and there is the demand for mechanical cooling, the head pressure control valve will open to 100%. When the compressor starts, the valve will modulate to maintain the factory set head pressure setpoint. The valve will be allowed to close to a minimum valve setpoint of 50%. If the compressor has been off for 10 minutes then the valve will close.

If the outside air temperature is below the summer setpoint (adjustable) and there is a demand for mechanical heating, the head pressure control valve will open fully and remain open until the compressor has been off for 10 minutes.

Frost Control (Selectable)

Recirculation Defrost

If the outside air temperature is below the frost control setpoint (selectable), frost control is enabled. Frost control timing varies depending upon strategy selected.

- Outside air damper closes.
- Recirculation damper opens.
- After delay, exhaust air damper closes and exhaust blower stops.
- Supply blower keeps running.
- Wheel stops.

Exhaust Only Defrost

If the outside air temperature is below the frost control setpoint (selectable), frost control is enabled. Frost control timing varies depending upon strategy selected.

- Outside air damper closes.
- Exhaust air damper is open.
- Recirculation damper stays closed (if equipped).
- Exhaust blower keeps running.
- Supply blower stops.
- Wheel keeps running.

Preheat Frost Prevention

If the outside air temperature is below the frost control setpoint (selectable), frost control is enabled.

If the preheater is on/off, first stage preheating is enabled. If the outside air temperature drops below the frost control setpoint plus the differential, second stage preheating is enabled. This process continues for the third and fourth stages of preheating.

If the preheater is modulating, the heater elements modulate to maintain the frost control setpoint (selectable).

Variable Speed Defrost (VSD) Frost Prevention

The VSD frost control setting is 33°F (selectable). If the exhaust air temperature drops below the VSD control setpoint (selectable), the wheel slows down to 30% of the nominal speed. The wheel continues to modulate to maintain the frost control setpoint.

Non-defrost

No defrost strategy is implemented.

DDC Interface



Figure 4: BacStat II

The BacStat II is the interface to the DDC. It is used to monitor unit operation, provide maintenance/fault feedback and allow the user to change setpoints. It is connected to terminals provided in the control panel area and can either be mounted on the unit (indoor units only), in the control panel area or remotely.

The display shown Figure 4 is the default display when it is idle for several minutes.

The top characters represent the supply air temperature leaving the unit. They also flash, once a second, when one of these conditions occurs:

'dF' = Unit is in frost control mode.

'FC' = Unit is in free cooling mode.

'CF' = Wheel has failed.

'LP' = Low pressure alarm has tripped. Requires a manual reset of DDC power after three failures.

'HP' = High pressure alarm has tripped. Requires manual reset of pressure switch.

'LL' = Coil low limit sensor has tripped (supplied by others).

'LS' = Low supply air temperature alarm. Requires manual reset of DDC power.

'HS' = High supply air temperature alarm. Requires manual reset of DDC power.

'OL' = Supply/exhaust overload has tripped.

Alternatively, it can be an external unit fault (supplied by others).

'EF' = Dirty exhaust filters.

'SF' = Dirty supply filters.

'FS' = Flow switch alarm or low water leaving temperature alarm.

The middle characters represent the mode the unit is in:

'Un' = Unoccupied.

'Ov' = Occupied ventilation.

'Or' = Occupied recirculation.

'Ur' = Unoccupied recirculation.

The bottom characters represent the supply air cooling/heating setpoint. If the zone configuration is set to discharge air control (MV11= NO) and the unit has hot gas reheat, then this will display the cooling setpoint in summer mode and the heating setpoint in the winter mode. If the unit does not have hot gas reheat then it will display the coil leaving setpoint in the summer mode. If the zone configuration is set to room or return air (MV11= RM or RET) then this will display the summer zone setpoint in the summer mode and the winter zone setpoint in the winter mode.

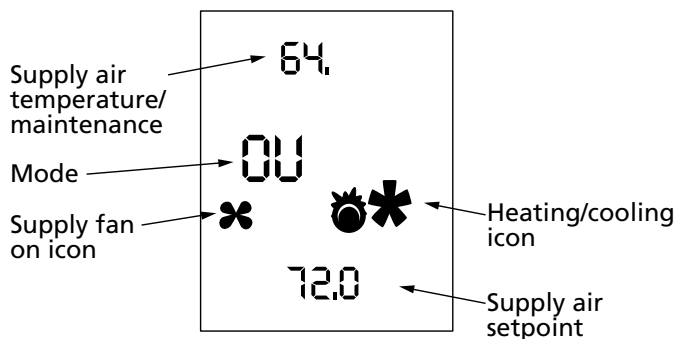

Figure 5: Main screen

To navigate through the setpoints, use the on and off buttons—on to go up, off to go down. To change the setpoints, use the up and down arrow buttons. Push once on the up button to go up, push it again to stop. See Appendix B for the entire read and read/write variables.

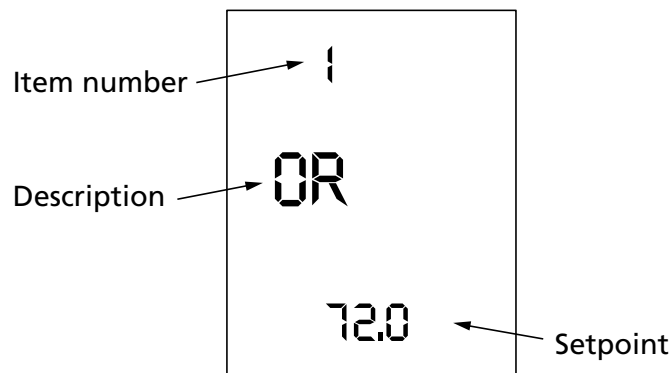

Figure 6: Changing setpoints

Appendix A: Control Wiring Connections Example

1. Complete wire connections between the unit and the exhaust air damper by matching the correct wire colors on the actuator and end switch with the wire colors on the schematic before installing (ACT4004, if applicable).
2. The supply air temperature sensor (SN3002) is included loose in the unit and can be found in the control panel. Install the temperature sensor a minimum of 12 feet downstream of the unit. The further the sensor is from the heating/cooling source, the greater the accuracy in readings because more air mixing is allowed. Wire it to IP4 on the DDC (DDC3002). A coil of wire can be found in the supply fan cabinet behind the fan (or in the gas cabinet if applicable). One end of this coil is connected to IP4 on the DDC (DDC3002).
3. Install the BacStat II (DC3036). It is included loose in the unit and can be found in the control panel. Determine required location and connect to terminals FW 380, 381, 382 and 383 using two twisted pair cables, the first for power connection. The LinkNet Cable needs to be balanced 100 to 120 ohm nominal impedance Twisted Shielded Pair Cable, Nominal capacitance of 16PF/FT or lower (see Appendix C for networking practice).
4. Units will require a dry contact start interlock. See [Stand Alone Operation](#) or [Network Operation](#) and [Ventilation Control Scheduling Modes](#). Determine required method, mode and terminals and make connection.

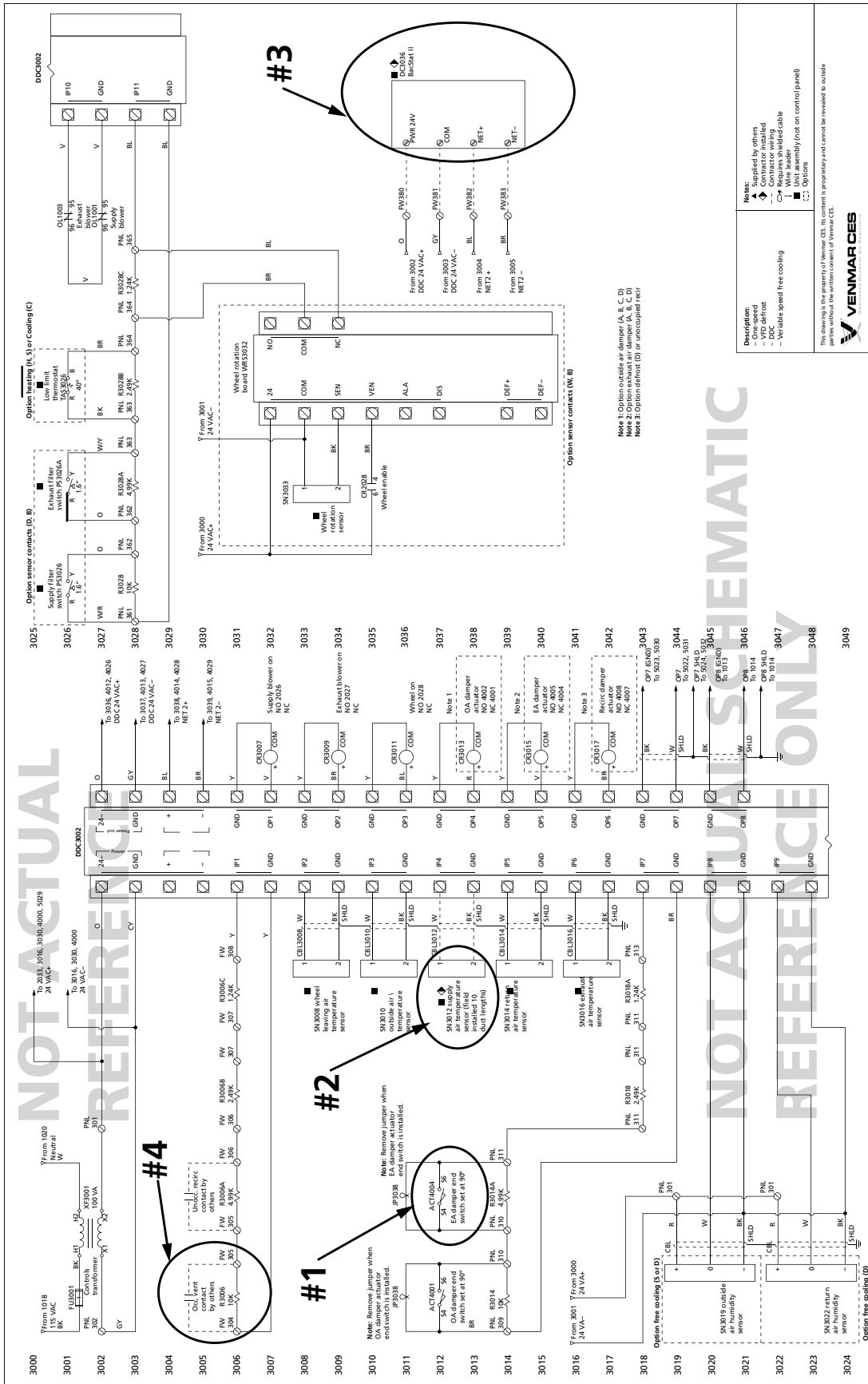

Figure A1: DDC control wiring connection example 1

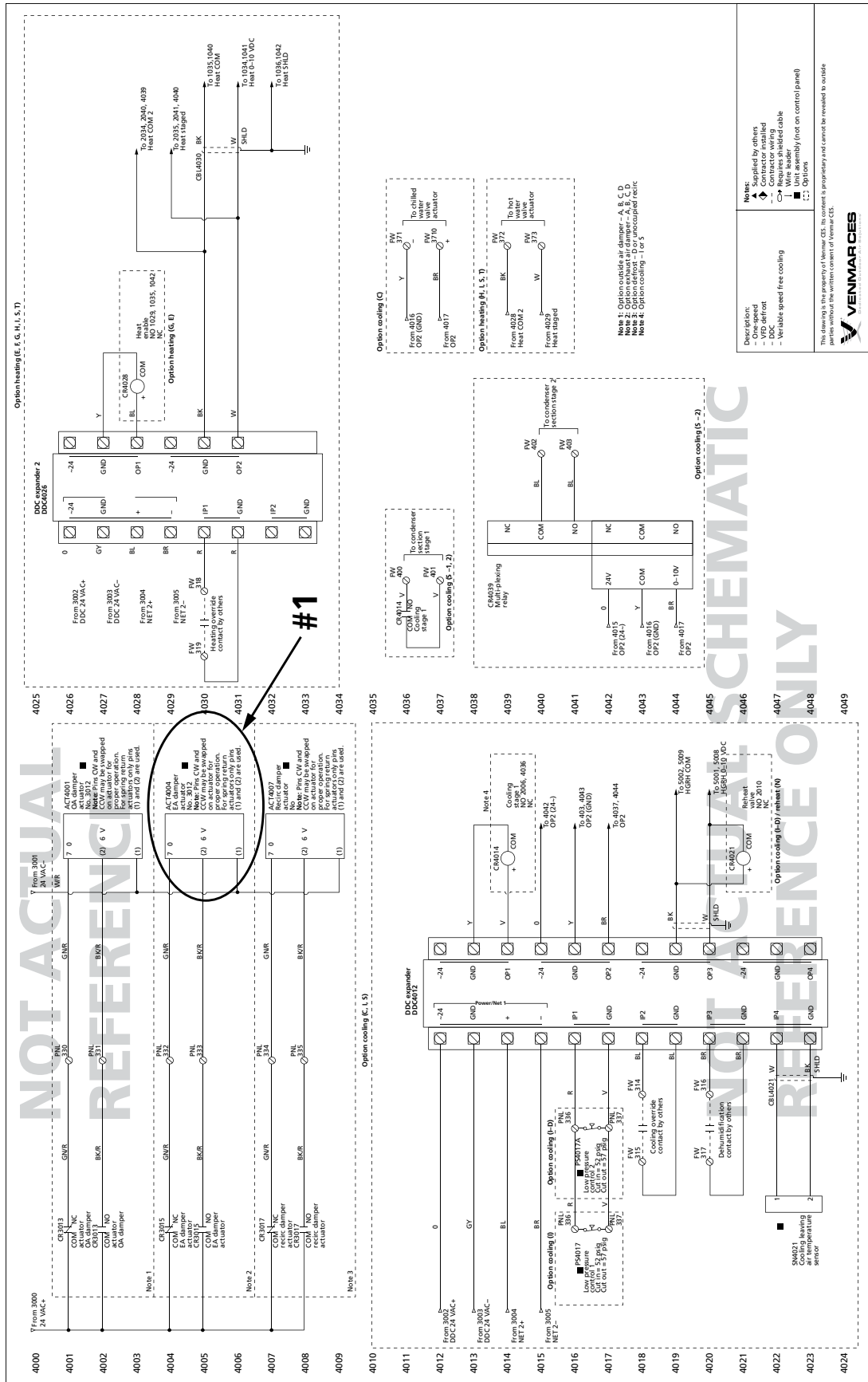

Figure A2: DDC control wiring connection example 2

Appendix B: DDC Points Reference Guide

Table B1: DDC Points Reference Guide

Item #	Description	Limits	Factory Set	BACnet Variable	Function
1	Ot1	N/A	N/A	AI3	Temperature reading.
2	St1	N/A	N/A	AI4	Temperature reading.
3	Rt1	N/A	N/A	AI5	Temperature reading.
4	Et1	N/A	N/A	AI6	Temperature reading.
5	OH1	N/A	N/A	AI7	Humidity reading.
6	RH1	N/A	N/A	AI8	Humidity reading.
7	On/off	On/off	N/A	BO1	Supply blower operation.
8	BAC	N/A	N/A	AI101	Temperature reading.
9	Prg	N/A	N/A	AV1000	Program ID.
10	Dpr	N/A	N/A	M17	UC (1) – Unconnected. NO (2) – No damper end switch made. ED (6) – Exhaust damper end switch made. OD (10) – Outside damper end switch made. OD/ED (14) – Outside and exhaust damper end switch made.
101	Stp	100°F–160°F [38°C–71°C]	160°F	AV2	Unit shuts down when supply temperature rises above this setpoint.
102	Stp	35°F–50°F [2°C–10°C]	35°F	AV3	Unit shuts down when supply temperature drops below this setpoint for the low limit delay.
103	Stp	0–15 minutes	5 minutes	AV4	Used in conjunction with the low limit setpoint. A time delay before the unit will shut down if the supply air drops below the low limit setpoint.
104	Stp	5°F–80°F [–15°C–27°C]	60°F	AV5	The summer setpoint is the temperature for the unit to change over between summer and winter modes of operation.
105	Stp	1°F–8°F [0.5°C–5°C]	4°F	AV6	The summer span is the differential above and below the summer setpoint.
106	Stp	0–100%	50%	AV7	The summer reset is the shift in the span below the summer setpoint by X%.
107	Stp	50°F–80°C [10°C–27°C]	60°F	AV10	The cooling setpoint is the temperature that the reheat will heat the supply air up to (summer mode only).
108	Stp	4°F–12°F [2°C–7°C]	4°F	AV11	The cooling span is the differential above and below the cooling setpoint.
109	Stp	0–75%	50%	AV12	The cooling reset is the shift in the span below the cooling setpoint by X%.
110	Stp	5–30 minutes	10 minutes	AV13	After a low pressure condition persists and shuts the compressor down, this is the amount of time before the DDC will try to restart the compressor.
111	Stp	50°F–105°F [10°C–40°C]	80°F	AV20	The heating setpoint is the temperature that the post heat will heat the supply air up to during discharge air temperature control (winter mode only).
112	Stp	4°F–20°F [2°C–12°C]	4°F	AV21	The heating span is the differential above and below the heating setpoint.
113	Stp	0–75%	50%	AV22	The heating reset is the shift in the span below the heating setpoint by X%.
114	Stp	1–30 minutes	4 minutes	AV23	After the heater has turned off, this is the minimum time that the DDC will wait before turning it back on.
115	Stp	40–80°F [4–27°C]	55°F	AV143	The coil leaving setpoint is the temperature that the cooling coil will cool the coil leaving air temperature down to during discharge air temperature control (summer mode only).
116	Stp	4°F–12°F [2°C–7°C]	4°F	AV144	The coil leaving span is the differential above and below the coil leaving setpoint.
117	Stp	0–75%	50%	AV145	The coil leaving reset is the shift in the span below the coil leaving setpoint by X%.

Table B1: DDC Points Reference Guide

Item #	Description	Limits	Factory Set	BACnet Variable	Function
118	Stp Coil override leaving setpoint	40°F-65°F [4°C-18°C]	50°F	AV146	The coil override leaving setpoint is the temperature that the cooling coil will cool the coil leaving air temperature down to during room air temperature/humidity control (summer mode only).
119	Stp Coil override leaving span	4-12°F [2-7°C]	4°F	AV147	The coil override leaving span is the differentials above and below the coil override leaving setpoint.
120	Stp Coil override leaving reset	0-75%	50%	AV148	The coil override leaving reset is the shift in the span below the coil override leaving setpoint by X%.
121	Stp Heating override setpoint	50°F-105°F [10°C-40°C]	90°F	AV140	The heating override setpoint is the temperature that the post heat will heat the supply air up to during room air temperature control (winter mode only).
122	Stp Heating override span	4°F-20°F [2°C-12°C]	4°F	AV141	The heating override span is the differential above and below the heating override setpoint.
123	Stp Heating override reset	0-75%	50%	AV142	The heating override reset is the shift in the span below the heating override setpoint by X%.
124	Stp Enthalpy free cooling setpoint	10-70 Btu/lbs [23-163 Joules/gram]	20 Btu/lbs	AV45	The enthalpy free cooling setpoint is the measured enthalpy that the unit will go into free cooling. Site elevation (AV153) may need to be updated
125	Stp Enthalpy free cooling span	5-20 Btu/lbs	5 Btu/lbs	AV46	The enthalpy free cooling span is the differential above and below the enthalpy setpoint.
126	Stp Enthalpy free cooling reset	0-100%	50%	AV47	The enthalpy free cooling reset is the shift in the span below the enthalpy free cooling setpoint by X%.
127	Stp Dry bulb free cooling setpoint	40°F-80°F [5°C-27°C]	65°F	AV60	The dry bulb free cooling setpoint is the temperature that the unit will go into free cooling. Used with VSD free cooling option
128	Stp Dry bulb free cooling span	4°F-20°F [2°C-12°C]	4°F	AV61	The dry bulb free cooling span is the differential above and below the free cooling setpoint. Used with VSD free cooling option.
129	Stp Dry bulb free cooling reset	0-100%	50%	AV62	The enthalpy free cooling reset is the shift in the span below the dry bulb free cooling setpoint by X%. Used with VSD free cooling option.
130	Stp Free cooling select	On/off	On	BV61	This variable enables or disables free cooling.
131	Stp Defrost setpoint	-5°F-50°F [-20°C-10°C]	5°F	AV65	The defrost setpoint is the temperature where the unit will go into defrost mode. (Defaults to 33°F for VFD defrost).
132	Stp Defrost span	2°F-10°F [1°C-5°C]	2°F	AV66	The defrost span is the differential above and below the defrost setpoint.
133	Stp Defrost reset	0-100%	50%	AV67	The defrost reset is the shift in the span below the defrost setpoint by X%.
134	Stp Electric reheat switch	On/off	Off	BV35	This variable enables or disables electric reheat. Enable this point only if you do not have HRG and you wish to use your electric post heat.
135	Stp				Factory set, do not change
136	Stp				Factory set, do not change
137	Stp				Factory set, do not change
138	Stp				Factory set, do not change
139	Stp				Factory set, do not change
140	Stp				Factory set, do not change
141	Stp				Factory set, do not change
142	Stp				Factory set, do not change
143	Stp Outside air damper minimum	0-100%	100%	AV150	The outside air damper minimum setpoint is set in conjunction with the exhaust air setpoint damper minimum setpoint to allow for the required recirculation air.
144	Stp Exhaust air damper minimum	0-100%	100%	AV151	The exhaust air damper minimum setpoint is set in conjunction with the outside air setpoint damper minimum setpoint to allow for the required recirculation air.

Table B1: DDC Points Reference Guide

Item #	Description	Limits	Factory Set	BACnet Variable	Function
145	Stp Burner minimum output	0-50%	0%	AV152	Used to set the minimum modulated output to the burner to avoid cycling. If Tega burner is used, it must be set to 12%.
146	Stp Site elevation	0-100 (x100) ft	10 (x100) ft	AV153	Used for enthalpy calculations.
147	Stp Summer zone setpoint	60°F-80°F [15°C-25°C]	70°F	AV84	The summer zone setpoint is the room or return air setpoint for summer mode.
148	Stp Summer zone span	1°F-8°F [0.5°C-5°C]	2°F	AV85	The summer zone span is the differential above and below summer zone setpoint.
149	Stp Summer zone reset	0-100%	50%	AV86	The summer zone reset is the shift in the span below the summer zone setpoint by X%.
150	Stp Winter zone setpoint	60°F-80°F [15°C-25°C]	70°F	AV87	The winter zone setpoint is the room or return air setpoint for winter mode.
151	Stp Winter zone span	1°F-8°F [0.5°C-5°C]	2°F	AV88	The winter zone span is the differential above and below winter zone setpoint.
152	Stp Winter zone reset	0-100%	50%	AV89	The winter zone reset is the shift in the span below the winter zone setpoint by X%.
153	Stp Zone configuration	NO - RET - RM	NO	MV11	The zone configuration allows the unit to be used for zone cooling/heating. NO = No zone control RET = Return air zone control (return air temperature sensor) RM = Room air zone control (Bacstat II temperature sensor**)
154	Stp Minimum supply temperature	Min. 40°F [5°C]	50°F	AV26	Used with RET or RM zone configuration. Protects the room from too low of a supply air temperature.
155	Stp Maximum supply temperature	Max. 120°F [49°C]	100°F	AV27	Used with RET or RM zone configuration. Protects the room from too high of a supply air temperature.
156	Stp Factory set, do not change				
157	Stp Factory set, do not change				
158	Stp Factory set, do not change				
159	Stp Factory set, do not change				
160	Stp Factory set, do not change				
161	Stp Factory set, do not change				
162	Stp Factory set, do not change				
163	Stp Factory set, do not change				
164	Stp Compressor delay	10-300 seconds	90 seconds	AV19	Delays compressor to allow the water valve(s) to open.
165	Stp Economizer select	On/off	Off	BV141	Enables or disables WSHHP Economizer coil.
166	Stp Economizer setpoint	40°F-105°F [-20°C-10°C]	65°F	AV180	Economizer entering water temperature setpoint.
167	Stp Unoccupied recirc supply fan option	On/off	Off	BV145	If Off and in Ur mode, supply fan only turns on with contact override. If On, then supply fan turns on when in Ur mode.
168	Stp Water leaving temperature setpoint	-4°F-50°F [-20°C-10°C]	35°F	AV185	Setpoint that will trip unit on low water freeze protection (optional).
169	Stp Factory set, do not change				
170	Stp Factory set, do not change				
199	Stp Conversion F to C	°F-°C	°F	BV99	This setting is used to change from Standard to SI units.
N/A	N/A Remote unit control		N/A	MV12	The remote unit control multi-state variable is used to enable the unit through a Bacnet inter. Set MV12 to (based on starting at a count of one): - 2 for unoccupied mode - 4 for occupied recirculation mode (optional) - 10 for ventilation mode - 6 for unoccupied recirculation mode (optional) Note: This variable can only be modified through a BMS

Appendix C: Standard Network Practice

Unit Control

The unit can be enabled in ventilation mode by jumpering FW 304 to 305. Alternatively the software point MV12 can be used to schedule the unit. If this method is being used then you must not provide any jumpers to terminals 304, 305, 306, 307 or 308.

The remote unit control multi-state variable is used to enable the unit through a Bacnet interface.

Set MV12 to:

- 2 for unoccupied mode.
- 4 for occupied recirculation mode (optional).
- 6 for unoccupied recirculation mode (optional).
- 10 for ventilation mode.

IMPORTANT

Values shown are based on starting at a count of one. When using Johnson Controls/Metasys, set the values one lower than shown as they start at zero.

BacNet Interface

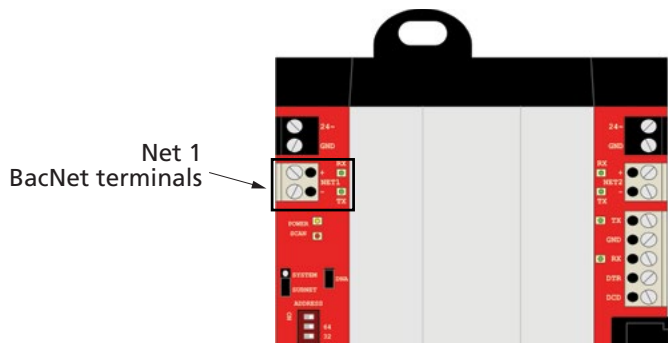

Figure C1: BacNet interface

Interface to the DSC-1180 controller by connecting to the “Net 1” terminal as seen below.

Networking Specifications

Venmar CES provides equipment with network integration features. The following section outlines basic practices as recognized in the industry. As an HVAC equipment manufacturer, it is not part of Venmar CES’ mission to provide exhaustive networking design and integration services. In all cases, the advice and services of a networking professional for network design and integration should be employed.

The DDC controllers provided along with Venmar CES equipment will support two types of network connection:

- RS232 (generally used for temporary local access to unit controller – i.e. troubleshooting)
- RS485 – the following specifications pertain to RS485 connection

Most commonly, RS485 is used as the physical layer between panels and unit controllers in HVAC networking

applications. See Table C1 for a summary of specifications concerning the application of RS485 networks.

Table C1: Summary of Specifications for a RS485 Network

Category	Specification
Cable type	100–120 ohm balanced, twisted shielded pair
Network configuration	Daisy chain
Maximum distance of chain	4,000 ft [1,200 m]
Maximum stub length	10” [0.25 m]
Minimum spacing between devices	12” [0.30 m]
Maximum number of devices	32 devices per daisy chain segment
Termination	Termination use DNT294 network terminator at both ends of a segment
Shielding	Connect shield to DNT294 network terminator

Cable Type

Venmar CES recommends the use of balanced 22 to 24 AWG twisted pair with a characteristic impedance of 100–120 ohms, capacitance of 17 pF/ft or lower, with a braided shield.

Network Configuration

RS485 networks use a daisy chain configuration (only one main cable, every device being connected directly along its path).

Figure C2 illustrates two improper network configurations and the proper daisy chain configuration.

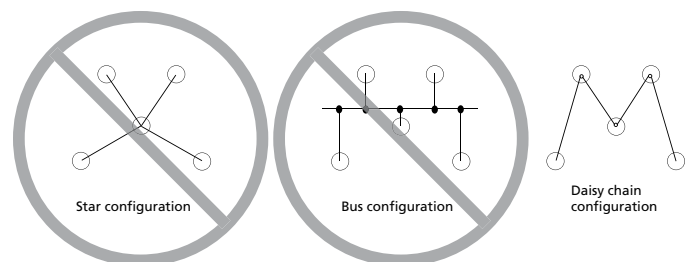

Figure C2: Network configurations – star, bus and daisy chain

Note that there are no troubleshooting methods for these improper types of networks.

The use of an improper network configuration may result in undesirable and unpredictable effects on unit functionalities.

Only the daisy chain configuration is correct for a RS485 network. Figure C3 shows connection in the middle of a daisy chain.

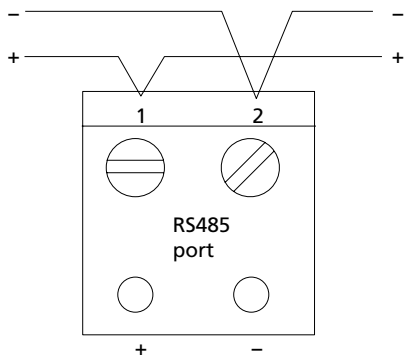

Figure C3: Proper connection in the middle of a daisy chain

Maximum Number of Devices

A maximum of 32 nodes are allowed on a single daisy chain segment. A node is defined as any device (Panel, Zone, Repeater, etc.) connected to the RS485 network. Terminators do not count as a node. Figure C3 shows an example of a system with 5 nodes.

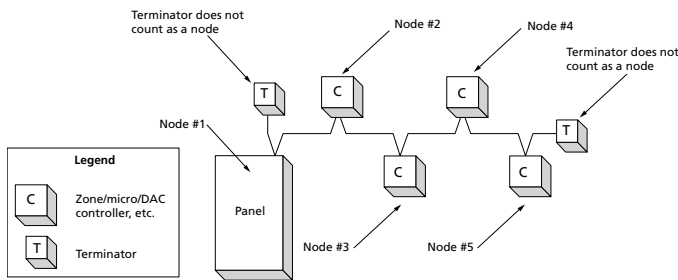

Figure C4: Five node network example

Termination

Both ends of a daisy chain segment require termination to ensure reliable operation. After the last device on each end of an RS485 network, install a DNT294 Network Terminator. The DNT294 (shown in Figure C5 below) provides the correct termination for not only the network, but proper termination of the shield as well.

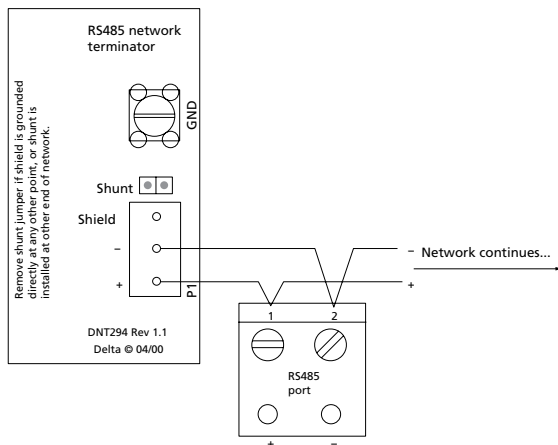

Figure C5: DNT294 network terminator

IMPORTANT

Note that DNT294 Network Terminators are not provided by Venmar CES.

Shielding and Grounding

Figure C6 shows preferred shielding and grounding methods.

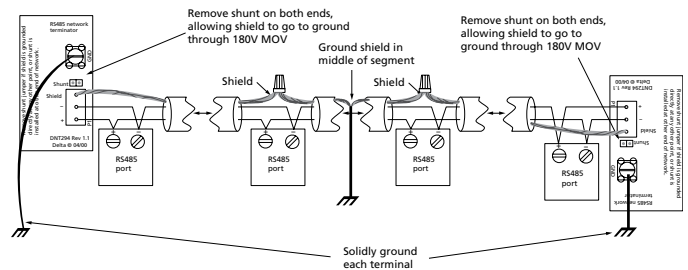

Figure C6: BacNet address jumpers

Unit Addressing

The BacNet address of a unit is sent out as address 1 from the factory. This address can be adjusted by setting the dip switches located on the DSC-1180 controller. See Figure C7.

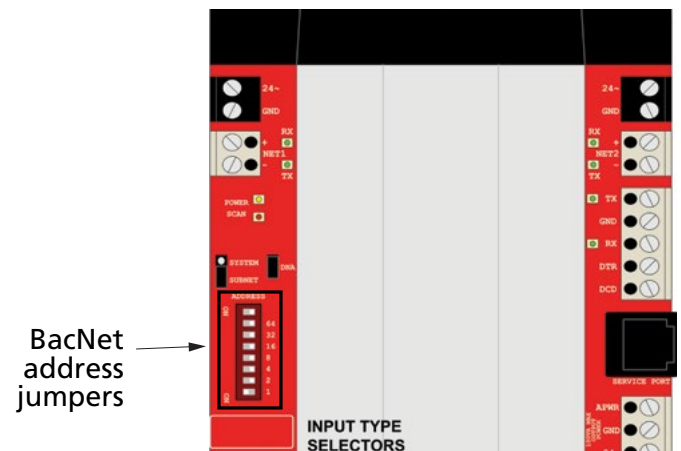

Figure C7: BacNet address jumpers

CAUTION

Failure to follow these recommendations may result in undesirable and unpredictable effects on unit functionalities. Venmar CES will not take responsibility for issues resulting from improper controls and/or networking practices.

Appendix D: DDC Troubleshooting Guide

All DDC units come with a “BacStat” which can act as a room thermostat where you can change the heating setpoint, cooling setpoint, summer setpoint and many more. The BacStat will act as a remote panel and should be looked at first when there is any issue with the unit.

Table D1: BacStat Keypad

Keypad Display	Description
dF	Unit is in frost control mode. (This is a status alarm. It does not indicate that there is a problem with the unit. It simply means that the unit is currently defrosting the wheel. This message will go away after the timed defrost sequence is complete.)
FC	Unit is in free cooling mode.
CF	Wheel has failed.
LP	Low pressure alarm has tripped. Requires manual reset of DDC power after three failures.
HP	High pressure alarm has tripped. Requires manual reset of pressure switch.
LL	Coil low limit sensor has tripped (supplied by others).
LS	Low supply air temperature alarm. Requires manual reset of DDC power.
HS	High supply air temperature alarm. Requires manual reset of DDC power.
OL	Supply/exhaust overload has tripped. Alternatively, it can be an external unit fault (supplied by others).
EF	Dirty exhaust filters.
SF	Dirty supply filters.
FS	Flow switch alarm or low water leaving temperature alarm.

The supply air sensor also functions like a low limit sensor. This is not to be confused with the “LL” alarm indicated above. This sensor has adjustable setpoint limit and time delay accessible through the BacStat points. If the supply air sensor is not connected, it will register as a -59 and the unit will not run after its time delay.

The middle characters represent the mode the unit is in:

Table D2: Unit Mode

Keypad Display	Mode
Un	Unoccupied
Or	Occupied recirculation
Ov	Occupied ventilation
Ur	Unoccupied recirculation

Table D3: DDC Troubleshooting Guide

Problem	Cause	Solution
Unit is not ventilating.	Occupancy contact open.	Check contact closure between field wiring terminals 304 and 305 (see wiring schematics in the VHC-36, 42 and 50 IOM for wiring details). Check the BacStat shows 'OV' for occupied ventilation.
	Blowers are overloaded.	BacStat will flash 'OL' in the upper left corner.
		Check motor overload trip indicator on overload relay (located below contactor). If it has tripped, press the reset button.
		Check for proper voltage at output of overload relay (T1, T2, T3) to confirm that the supply and exhaust blower motors are running.
	Low limit thermostat tripped.	BacStat will show 'LL' for low limit. Low limit sensor is supplied by others.
	Supply air sensor not hooked up.	BacStat will show a temperature in the top right corner in the range of -59 to -50. Hook up the sensor that was supplied with the unit.
Unit is in recirculation/exhaust defrost mode.	BacStat will flash 'dF' in the upper left corner. Wait for defrost mode to finish its timed sequence (minimum of six (6) minutes).	
Unit is not recirculating (for units with a recirculation damper).	Unoccupied recirculation contact open.	Check contact closure between field wiring terminals 305 and 306 (see wiring schematics in the VHC-36, 42 and 50 IOM for wiring details). BacStat will flash 'OL' in the upper left corner.
	Supply blower not running.	Check motor overload trip indicator on overload relay (located below contactor). If it has tripped, press the reset button.
Unit will not stop ventilating.	Occupancy contact closed.	Check contact for break between field wiring terminals 304 and 305 (see wiring schematics in the VHC-36, 42 and 50 IOM for wiring details).
Air from supply diffusers too cold.	Imbalance of supply and exhaust air.	Check filters and heat exchanger for blockage.
		BacStat will flash 'SF' or 'EF' to indicate supply or exhaust filters are dirty.
	Post heat required.	Check balance of airflows. Install post heat module.
Wheel failure.	BacStat will flash 'CF' in the upper left corner if wheel failure is detected (units with wheel rotation board).	
Unit makes an annoying noise.	Blower wheel out of alignment.	Remove the motor/blower assembly. Adjust the blower assembly.
Enthalpy wheel freezing.	Imbalance of supply and exhaust air.	Check filters and heat exchanger for blockage.
		Confirm supply filter needs replacing.
		Confirm exhaust filter needs replacing.
		Check balance of airflows.
	Check for operation of damper actuators.	
Defrost mode not functioning.	Confirm that the unit is in defrost mode. BacStat II will flash 'dF' in upper left corner. See defrost sequence of operation in the Frost Control section of this document.	
Enthalpy wheel not running.	Unit is in free cooling.	Confirm that the unit is in free cooling mode.
	Unit is in recirculation defrost.	BacStat will flash 'dF' in upper left corner.
	Wheel failure.	Units with wheel rotation sensor.
		BacStat will flash 'CF' indicating wheel rotation failure. Check relays and verify that motor is getting power.
	Drive motor capacitor failure.	Check capacitor connections. Check motor operation with a new capacitor.
Drive pulley.	Check for drive belt derailment off of drive pulley or failure. Check for securely fastened pulley on motor shaft.	

Table D3: DDC Troubleshooting Guide

Problem	Cause	Solution
Exhaust fan will not turn on.	Unit is in recirculation defrost (units equipped with recirculation defrost).	BacStat will flash 'dF' in upper left corner. Wait for defrost mode to finish its timed sequence.
	Unit is in unoccupied recirculation (units with recirculation damper).	BacStat will show 'UR'. Check if you have a contact closure across 305 and 306.
	Damper end switches are not making.	Check your field wires connected to PNL 310 and 311 for a closed connection.
Damper will not open.	Electrical supply interrupted.	Check wiring on damper actuator.
		For the outside air damper actuator and recirculation damper actuator (if equipped), measure a 24 VAC across PNL terminals 330 and 302.
		For the exhaust air damper actuator, measure a 24 VAC across factory wired terminals 332 and 302.
Supply fan will not turn on.	Unit is in exhaust defrost (units equipped with exhaust defrost).	BacStat will flash 'dF' in upper left corner. Wait for defrost mode to finish its timed sequence.
	Damper end switches are not making.	Check field wires connected to PNL 309 and 310 for a closed connection.
Additional Troubleshooting: ___ Verify DDC jumpers are correct. ___ Verify expander board jumpers and address (dip switch settings) are correct.		



info@venmarces.com
www.venmarces.com

Venmar CES Inc. has a policy of continuous improvement and reserves the right to change design and specifications without notice.

©2009 Venmar CES Inc.
VCES-DDC-IOM-1C (PN 500020459)
February 2014